

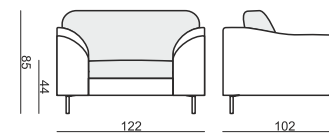

ARMCHAIR

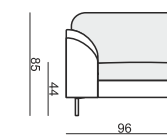

ARMCHAIR LEFT (or RIGHT)



ARMCHAIR without ARMRESTS

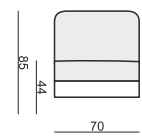

ARMCHAIR WIDE

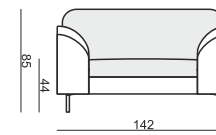

ARMCHAIR WIDE LEFT (or RIGHT)

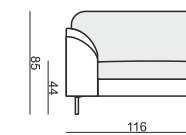

ARMCHAIR WIDE without ARMRESTS

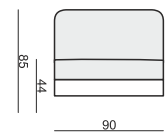

2 SEATER

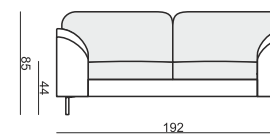

2 SEATER LEFT (or RIGHT)

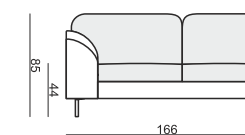

2 SEATER without ARMRESTS

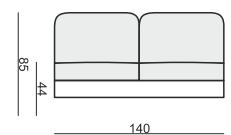

3 SEATER

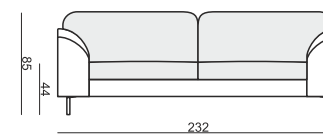

3 SEATER LEFT (or RIGHT)

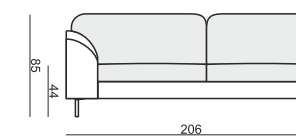

3 SEATER without ARMRESTS

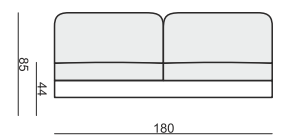

CHAISELONGUE LEFT (or RIGHT)

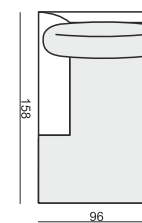

CHAISELONGUE WIDE LEFT (or RIGHT)

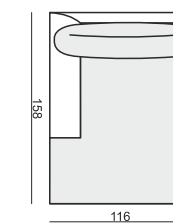

DIVAN LEFT (or RIGHT)

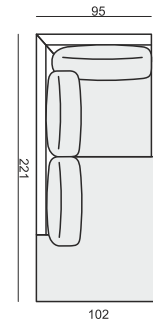

COZY CORNER LEFT (or RIGHT)

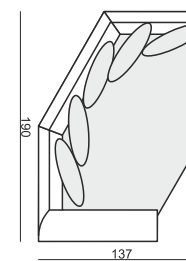

CORNER 90° No.1

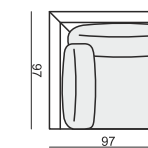

CORNER 90° No.2

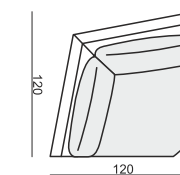

FOOTSTOOL

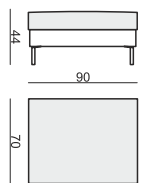

ENDPART LEFT (or RIGHT)
cm 95 x 4 x 58 H

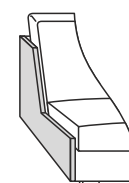

HEADREST L-77

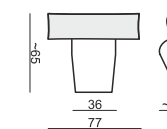

HEADREST L-62

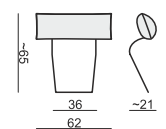

SET 1 LEFT (or RIGHT)
CHAISELONGUE LEFT (or RIGHT) + 2 SEATER RIGHT (or LEFT)

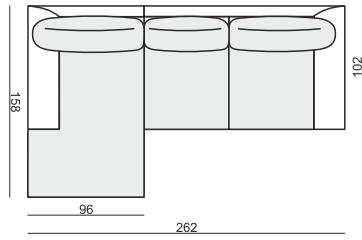

SET 2 LEFT (or RIGHT)
CHAISELONGUE WIDE LEFT (or RIGHT) + 3 SEATER RIGHT (or LEFT)

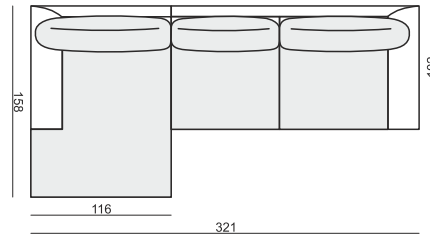

SET 3 LEFT (or RIGHT)
DIVAN LEFT (or RIGHT) + 2 SEATER RIGHT (or LEFT)

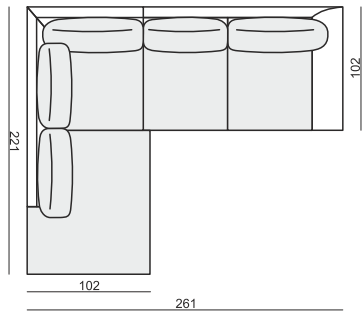

SET 4 LEFT (or RIGHT)
DIVAN LEFT (or RIGHT) + 3 SEATER RIGHT (or LEFT)

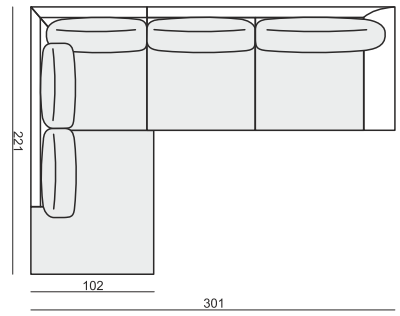

SET 5 LEFT (or RIGHT)
COZY CORNER LEFT (or RIGHT) + 3 SEATER RIGHT (or LEFT)

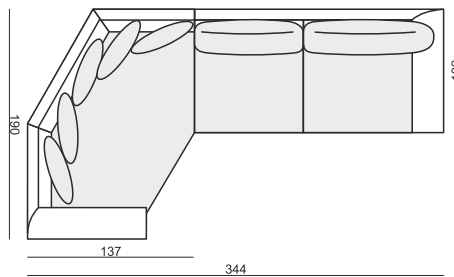

SET 6
DIVAN LEFT + 2 SEATER without ARMRESTS + DIVAN RIGHT

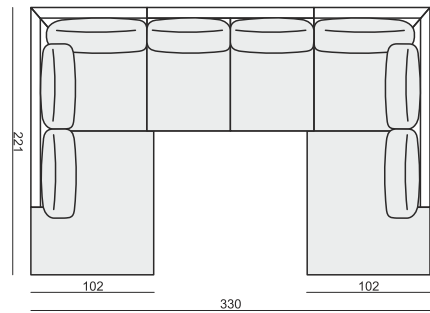

SET 7 LEFT (or RIGHT)
DIVAN LEFT (or RIGHT) + 2 SEATER without ARMRESTS + CHAISELONGUE RIGHT (or LEFT)

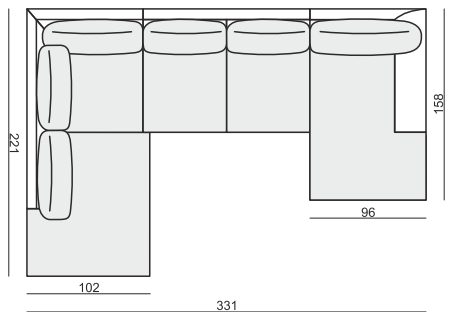

SET 8 LEFT (or RIGHT)
2 SEATER LEFT (or RIGHT) + CORNER 90° No.1 + 3 SEATER RIGHT (or LEFT)

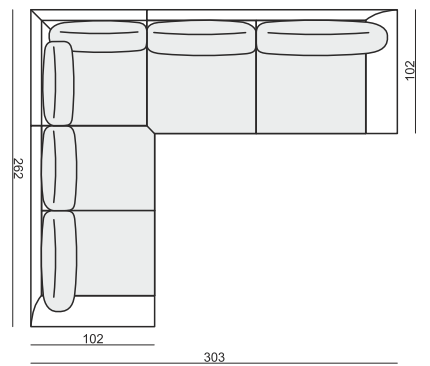

SITS reserves the right to change construction of products and components used due to improving durability of product and customer satisfaction without any further notice. Explicit ±2 cm tolerance of all elements sizes.

SET 9 LEFT (or RIGHT)
2 SEATER LEFT (or RIGHT) + CORNER 90° No.2 + 3 SEATER RIGHT (or LEFT)

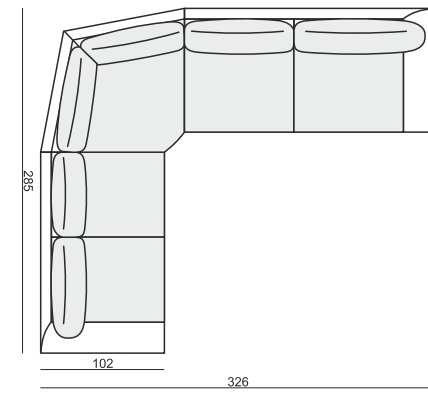

SET 10 LEFT (or RIGHT)
CHAISELONGUE LEFT (or RIGHT) + 2 SEATER without ARMRESTS + CORNER 90° No.1 + 2 SEATER RIGHT (or LEFT)

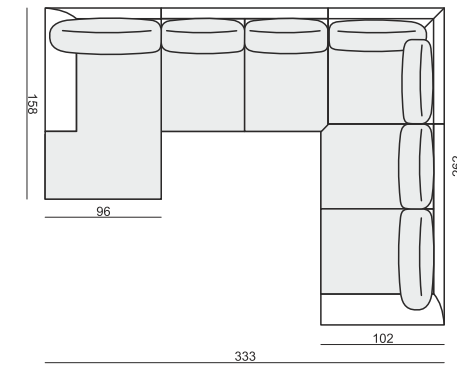

UPHOLSTERY

FABRIC: FC - fix cover or LC - loose cover

FEET

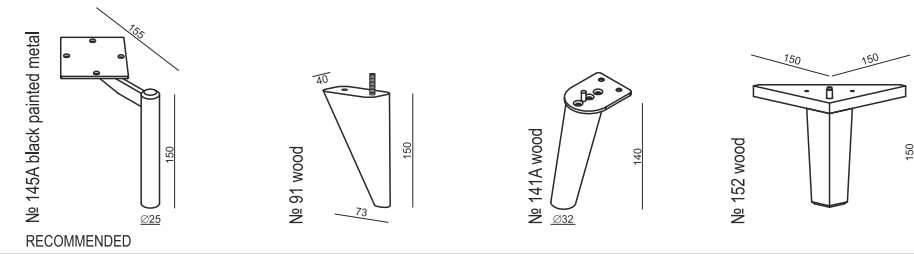

STANDARD COMFORT

LUX COMFORT