

Alex

SITS



Alex

UPHOLSTERY



fabric



leather

COMFORTS



STD standard

COVERS



FC fixed

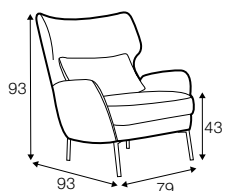

armchair

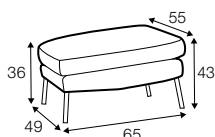

footstool

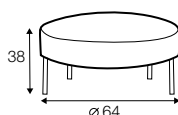

footstool round

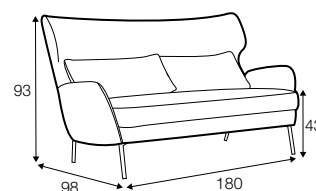

2,5 seater

accessories

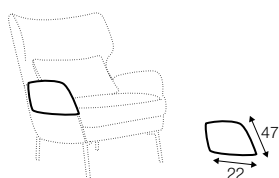

armrest protection

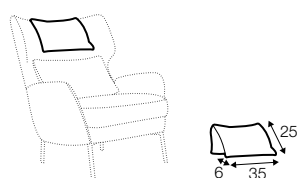

pillow

extra dimensions

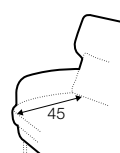

depth of
armchair seat

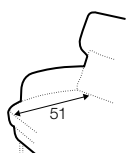

depth of
sofa seat

legs

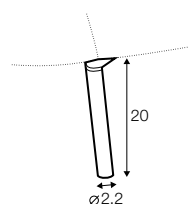

no. 160
metal chrome,
painted black or grey
and brushed steel*
front: armchair,
footstool, sofa

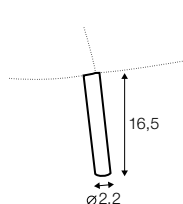

no. 160A
metal chrome,
painted black or grey
and brushed steel*
back: armchair,
footstool

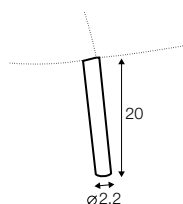

no. 160C
metal chrome,
painted black or grey
and brushed steel*
footstool round

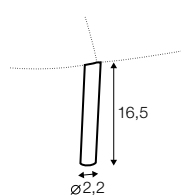

no. 160D
metal chrome,
painted black or grey
and brushed steel*
back: sofa

*please check a cost of brushed steel finish with a sale representative.

profile

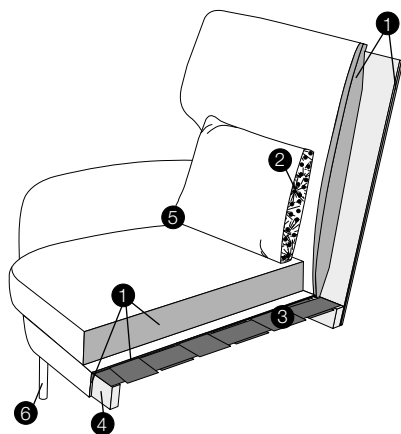

standard

1. polyurethane foam/high resilient polyurethane foam
2. cushion chamber with mix of feather and silicone balls
3. upholstery belts
4. FSC® certified solid wood and wood based elements
5. fabric or leather
6. painted metal, chrom or brushed legs