

Lukas

SITS



Lukas

UPHOLSTERY



fabric



leather

COMFORTS



STD standard

COVERS



FC fixed

SPECIAL



sofa bed

Drawings show combinations with armrest II. Combinations with armrest I and III are properly longer or shorter in width.

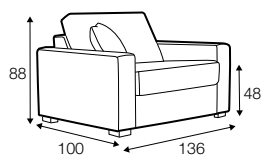

armchair sofa bed

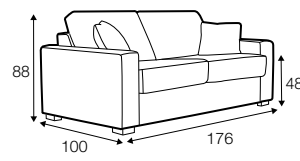
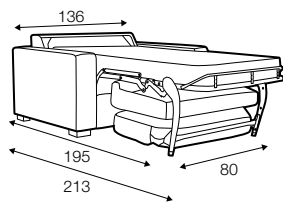

sofa bed 2

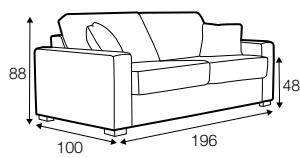
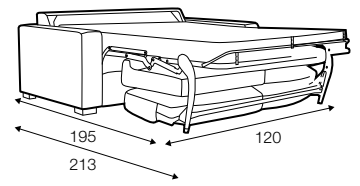

sofa bed 3

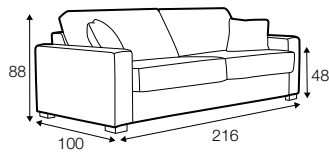
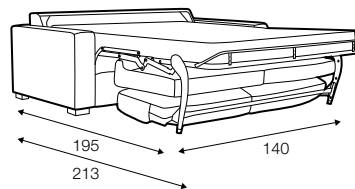

sofa bed 4

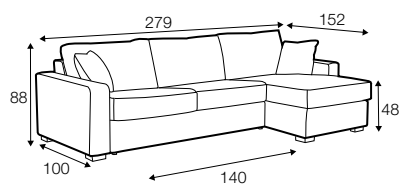
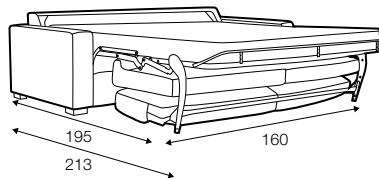

set 1 right / or left

sofa bed 3 left / or right + chaiselongue right / or left

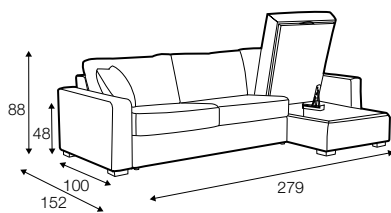
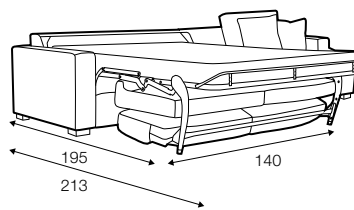

set 2 right / or left

sofa bed 3 left / or right + chaiselongue with box right / or left

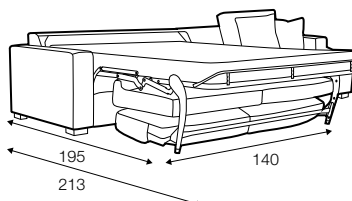

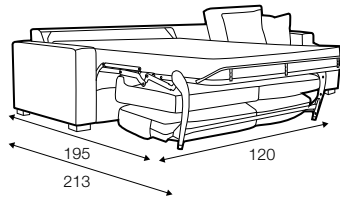
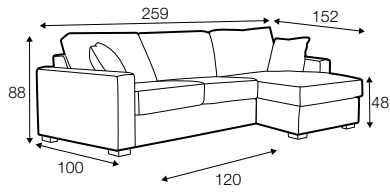

set 3 right / or left

sofa bed 2 left / or right + chaiselongue right / or left

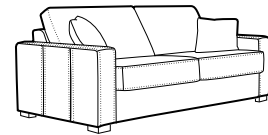
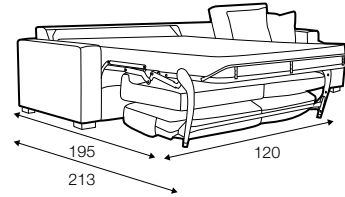
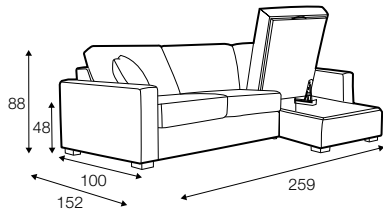

set 4 right / or left

sofa bed 2 left / or right + chaiselongue with box right / or left

example of leather cover
3 seater

extra dimensions

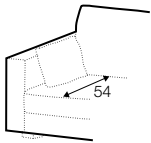

depth of seat

accessories

Two types of mattress: foam / or bonnel.

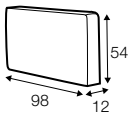
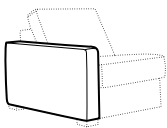

armrest I

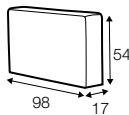
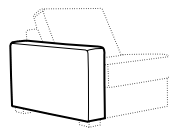

armrest II

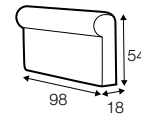
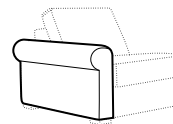

armrest III

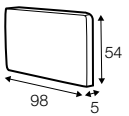
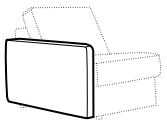

armrest IV

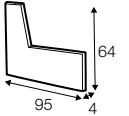
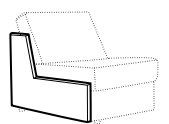

endpart left / or right

legs



no. 21
wood
armrest II

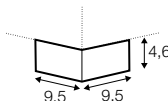

no. 21B
wood
armrest I, armrest III

plastic support
armrest IV, endpart

profile

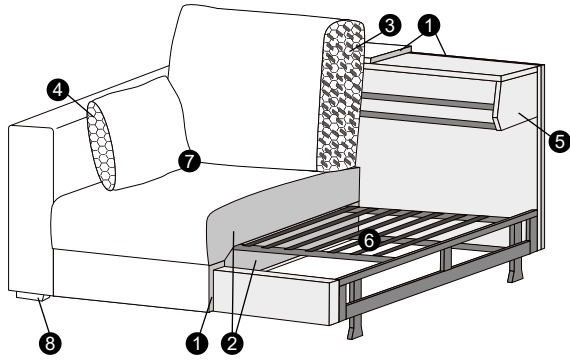

standard

1. polyurethane foam/ high resilient polyurethane foam
2. polyurethane foam or bonnell springs mattress
3. foam flakes with silicone balls
4. silicone balls
5. FSC® certified solid wood and wood based elements
6. metal mechanism
7. fabric or leather
8. FSC® certified solid wood legs