

Ville

SITS



Ville

UPHOLSTERY COMFORTS

COVERS

SPECIAL



fabric



STD standard



FC fixed



modular system

Buttons available in one colour.

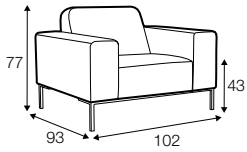

armchair

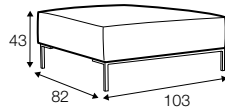

footstool 103x82

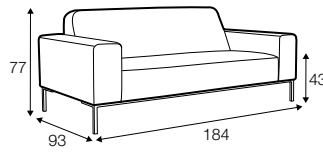

2 seater

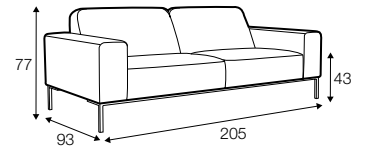

3 seater

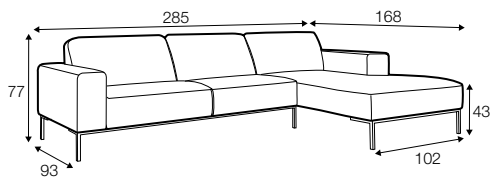

set 1 right / or left

3 seater left / or right + chaiselongue right / or left

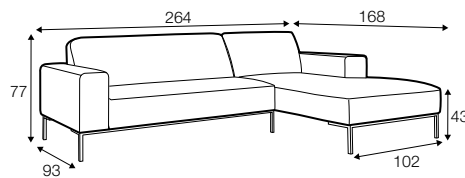

set 2 right / or left

2 seater left / or right + chaiselongue right / or left

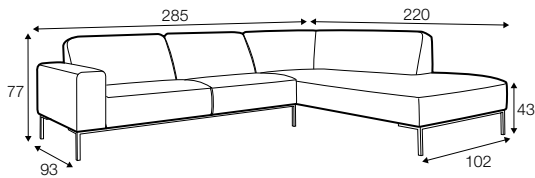

set 3 right / or left

3 seater left / or right + divan right / or left

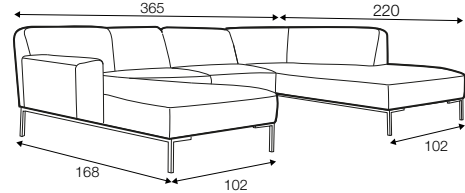

set 4 right / or left

chaiselongue right / or left + 3 seater without armrests + divan right / or left

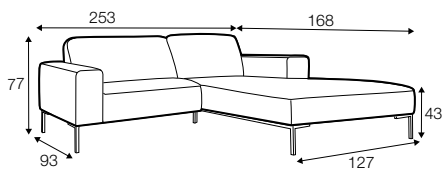

set 5 right / or left

armchair wide left / or right + chaiselongue wide right / or left

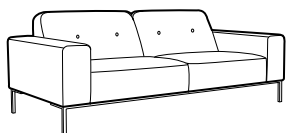

example with buttons
3 seater

modular system

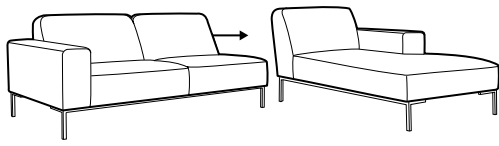

elements of the modular system

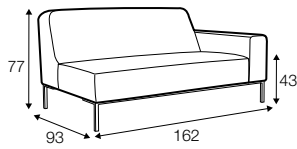

2 seater right / or left

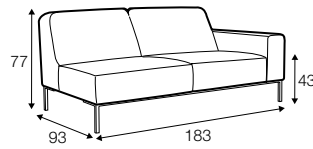

3 seater right / or left

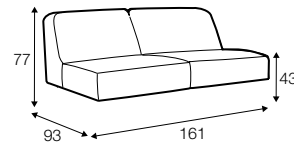

3 seater
without armrests

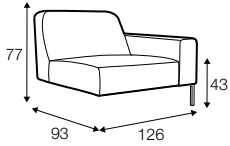

armchair wide
right / or left

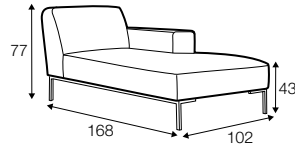

chaiselongue right / or left

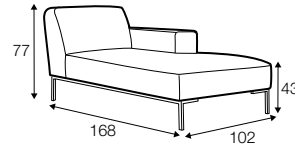

chaiselongue right / or left
freestanding

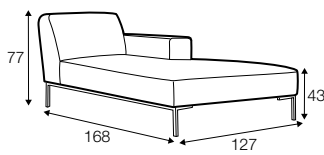

chaiselongue wide
right / or left

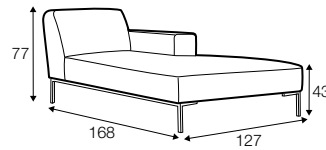

chaiselongue wide
right / or left freestanding

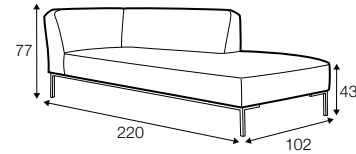

divan right / or left

extra dimensions

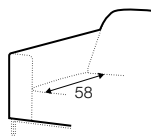

depth of seat

legs

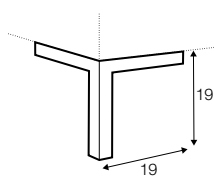

no. 146
metal chrome,
painted black or grey
front and back

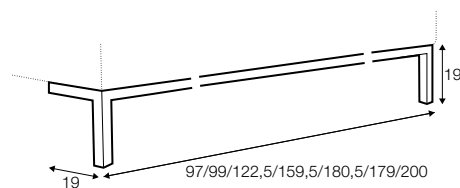

no. 146A
metal chrome,
painted black or grey
only front

profile

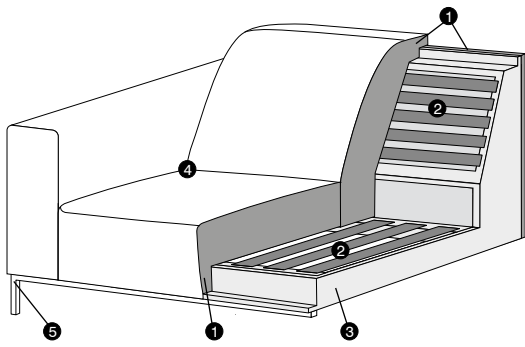

standard

1. polyurethane foam/ high resilient polyurethane foam
2. upholstery belts
3. FSC® certified solid wood and wood based elements
4. fabric
5. metal legs