

Luca

SITS



# Luca

## UPHOLSTERY



fabric

\*\*



leather  
only in FC

## COMFORTS



STD standard



CLS classic



LUX lux



PLUS plus

## COVERS



FC fixed



LCV loose with velcro

## SPECIAL



modular  
system

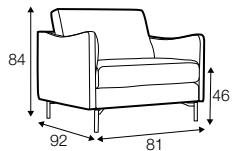

armchair

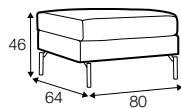

footstool 80x64

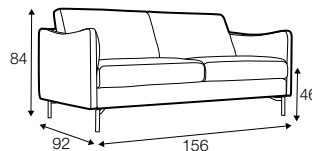

2 seater

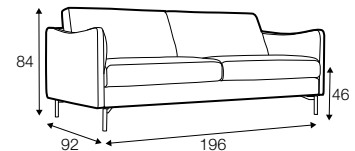

2,5 seater

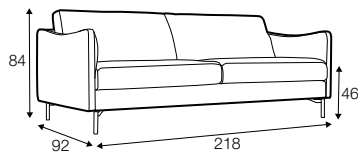

3 seater

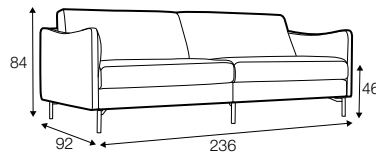

4 seater divided

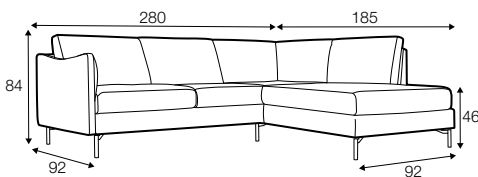

set 4 right / or left

2,5 seater left / or right + divan right / or left

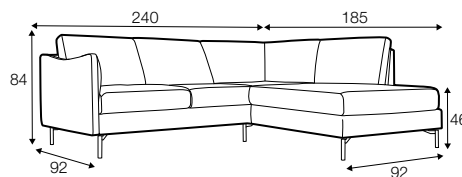

set 5 right / or left

2 seater left / or right + divan right / or left

## modular system

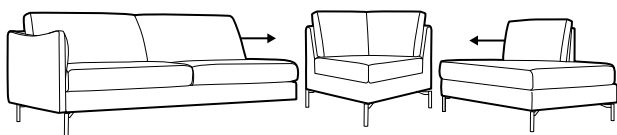

## elements of the modular system

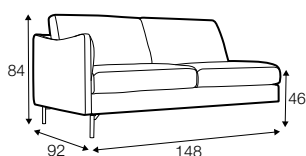

2 seater  
left / or right

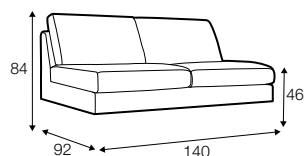

2 seater  
without armrests

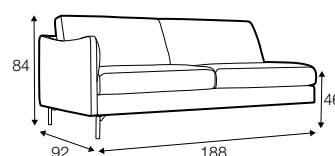

2,5 seater  
left / or right

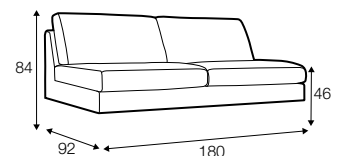

2,5 seater  
without armrests

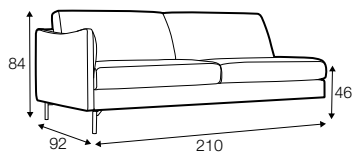

3 seater left / or right

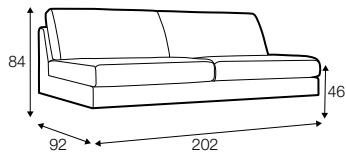

3 seater without armrests

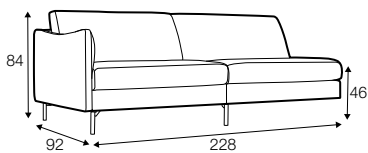

4 seater left / or right divided

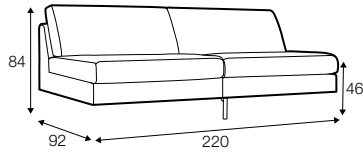

4 seater without armrests divided

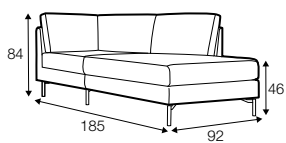

divan right / or left

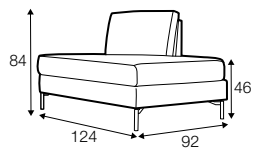

bench right / or left

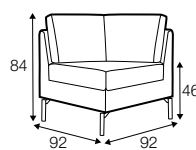

corner 90°

### extra dimensions

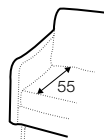

depth of seat

### accessories

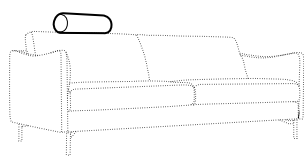

headrest with roll L-60

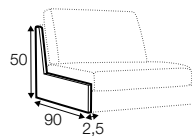
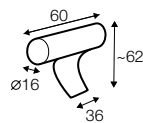

endpart left / or right

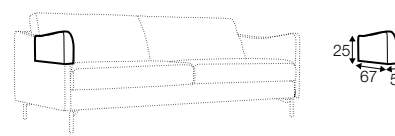

armrest protection

### legs

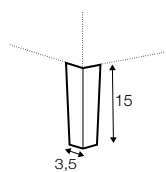

no. 109  
wood

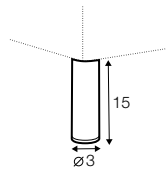

no. 111D  
metal chrome,  
painted black or grey  
and brushed steel\*

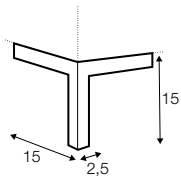

no. 124  
metal chrome,  
painted black or grey  
and brushed steel\*

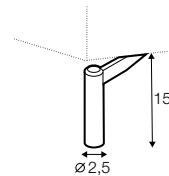

no. 145  
metal chrome,  
painted black or grey  
and brushed steel\*

\*please check a cost of brushed steel finish with a sale representative.

## profile

---

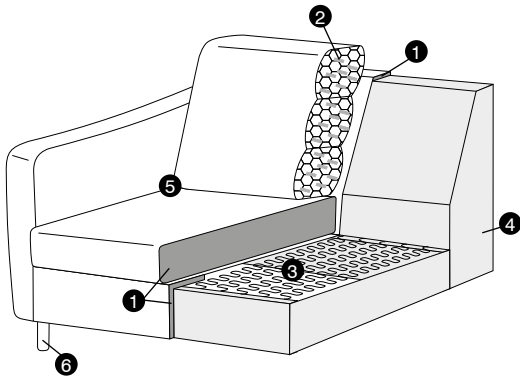

### standard

1. polyurethane foam / high resilient polyurethane foam
2. foam flakes with silicone balls
3. springs
4. FSC® certified solid wood and wood based elements
5. fabric
6. FSC® certified solid wood or metal legs

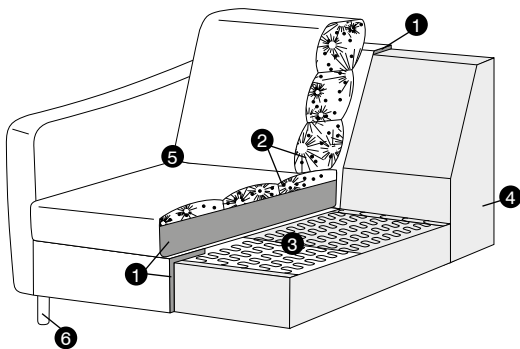

### lux

1. polyurethane foam/high resilient polyurethane foam
2. cushion chamber with mix of feather and silicone balls
3. springs
4. FSC® certified solid wood and wood based elements
5. fabric or leather
6. FSC® certified solid wood or metal legs

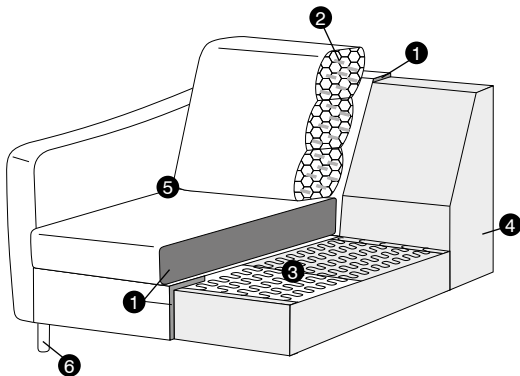

### classic

1. polyurethane foam/high resilient polyurethane foam
2. foam flakes with silicone balls
3. springs
4. FSC® certified solid wood and wood based elements
5. fabric or leather
6. FSC® certified solid wood or metal legs

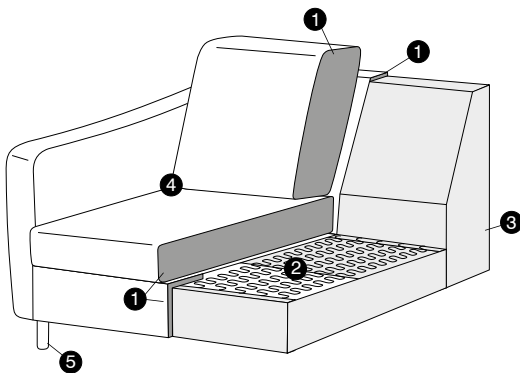

### plus

1. polyurethane foam/high resilient polyurethane foam
2. springs
3. FSC® certified solid wood and wood based elements
4. fabric or leather
5. FSC® certified solid wood or metal legs